



Instruction manual crm+ Ultrasonic Sensors with one analogue output

crm+25/IU/TC/E
crm+35/IU/TC/E
crm+130/IU/TC/E
crm+340/IU/TC/E
crm+600/IU/TC/E

Product description

- The crm+sensor with one analogue output measures the distance to an object within the detection zone contactless. A signal proportional to distance is created according to the adjusted window margins of the analogue characteristic curve.
- The ultrasonic transducer surface of the crm+sensors is laminated with a PEEK film. The transducer itself is sealed against the housing by a PTFE joint ring. This composition ensures a high resistance against many aggressive substances.
- The sensor automatically detects the load put to the analogue output and switches to current output or voltage output respectively.
- All settings are done with two push-buttons and a three-digit LED-display (TouchControl).
- Light emitting diodes (three-colour LEDs) indicate all operation conditions.
- Choosing between rising and falling output characteristic is possible.
- The sensors are adjustable manually using the numerical LED-display or may be trained using Teach-in processes.

- Useful additional functions are set in the Add-on-menu.
- Using the LinkControl adapter (optional accessory) all TouchControl and additional sensor parameter settings may be made by a Windows-Software.

Safety Notes

- Read the operating instructions prior to start-up.
- Connection, installation and adjustment works may only be carried out by expert personnel.
- No safety component in accordance with the EU Machine Directive.

The crm+sensors indicate a blind zone, in which the distance cannot be measured. The operating range indicates the distance of the sensor that can be applied with normal reflectors with sufficient function reserve. When using good reflectors, such as a calm water surface, the sensor can also be used up to its maximum range. Objects that strongly absorb (e.g. plastic foam) or diffusely reflect sound (e.g. pebble stones) can also reduce the defined operating range.

Synchronisation

If the assembly distances shown in Fig.1 for two or more sensors are exceeded the integrated synchronisation should be used. Connect Sync/Com-channels (pin 5 at the units receivable) of all sensors (10 maximum).

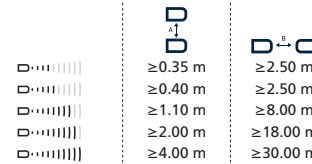

Fig. 1: Assembly distances, indicating synchronisation/multiplex

Multiplex mode

The Add-on-menu allows to assign an individual address »01« to »10« to each sensor connected via the Sync/Com-channel (Pin5). The sensors perform the ultrasonic measurement sequentially from low to high address. Therefore any influence between the sensors is rejected. The address »00« is reserved to synchronisation mode and deactivates the multiplex

mode. (To use synchronised mode all sensors must be set to address »00«.)

Assembly instructions

- Assemble the sensor at the installation location.
- Plug in the connector cable to the M 12 connector

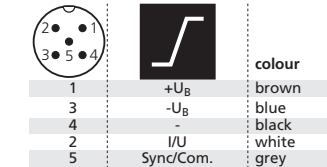

Fig. 2: Pin assignment with view onto sensor plug and colour coding of the microsonic connection cable

Start-up

- crm+ sensors are delivered factory made with the following settings:
- Rising analogue characteristic

- Window margins for the analogue output set to blind zone and operating range
- Measurement range set to maximum range

Set the parameters of the sensor manually or use the Teach-in procedure to adjust the detect points.

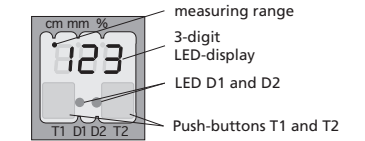

Fig. 3: TouchControl

Operation

crm+sensors work maintenance free. Small amounts of dirt on the surface do not influence function. Thick layers of dirt and caked-on dirt affect sensor function and therefore must be removed.

Note

- As a result of the design the assembly of PEEK film and PTFE joint ring is not gas-proof.
- The chemical resistance has to be tested experimentally if necessary.
- crm+sensors have internal temperature compensation. Because the sensors heat up on their own, the temperature compensation reaches its optimum working point after approx. 30 minutes of operation.
- If an object is within the set window margins of the analogue output, then LED D1 lights up green, if the object is outside the window margins, then LED D1 lights up red.
- The load put to the analogue output is detected automatically when turning supply voltage on.
- During normal mode operation, the measured distance value is displayed on the LED-indicator in mm (up to 999 mm) or cm (from 100 cm). Scale switches automatically and is indicated by a point on top of the digits. Alternatively a percentage scale may be set in the add-on menu. In this connection 0% and 100% correspond to the set window margins of the analogue output.
- If no objects are placed within the detection zone the LED-indicator shows »-«.
- If no push-buttons are pressed for 20 seconds during parameter setting mode the made changes are stored and the sensor returns to normal mode operation.

Show parameters

Tapping push-button T1 shortly during normal mode operation shows »PA« on the LED-display. Each time you tap push-button T1 the actual settings of the analogue output are shown.

Contact

Sensor Partners BV

James Wattlaan 15
5151 DP Drunen
The Netherlands

+31 (0)416 - 37 82 39
info@sensorpartners.com
sensorpartners.com

Sensor Partners BVBA

Z.1 Researchpark 310
B-1731, Zellik
Belgium

+32 (0)2 - 464 96 90
info@sensorpartners.com
sensorpartners.com

Set sensor parameters alternatively numerically using LED-display...

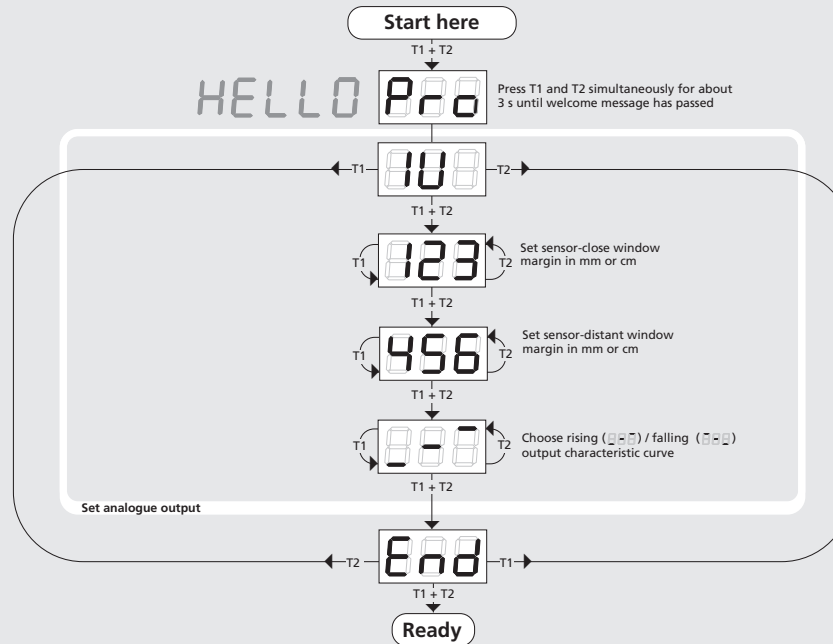

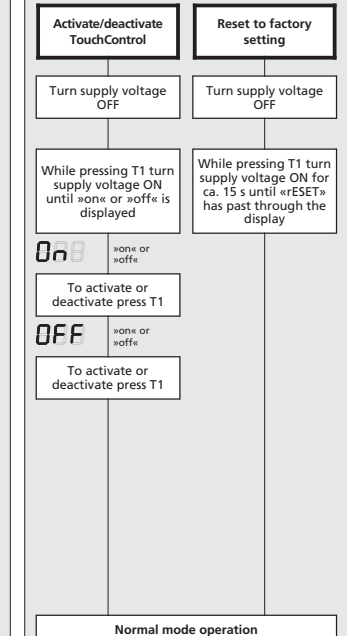
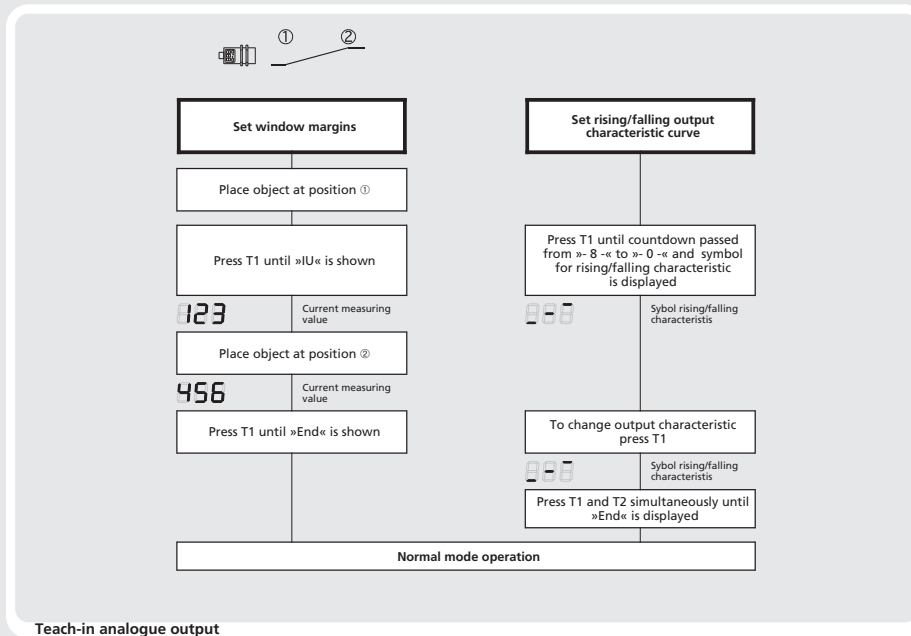

Usefull additional functions in Add-on menu (for experienced users only, settings not required for standard applications)

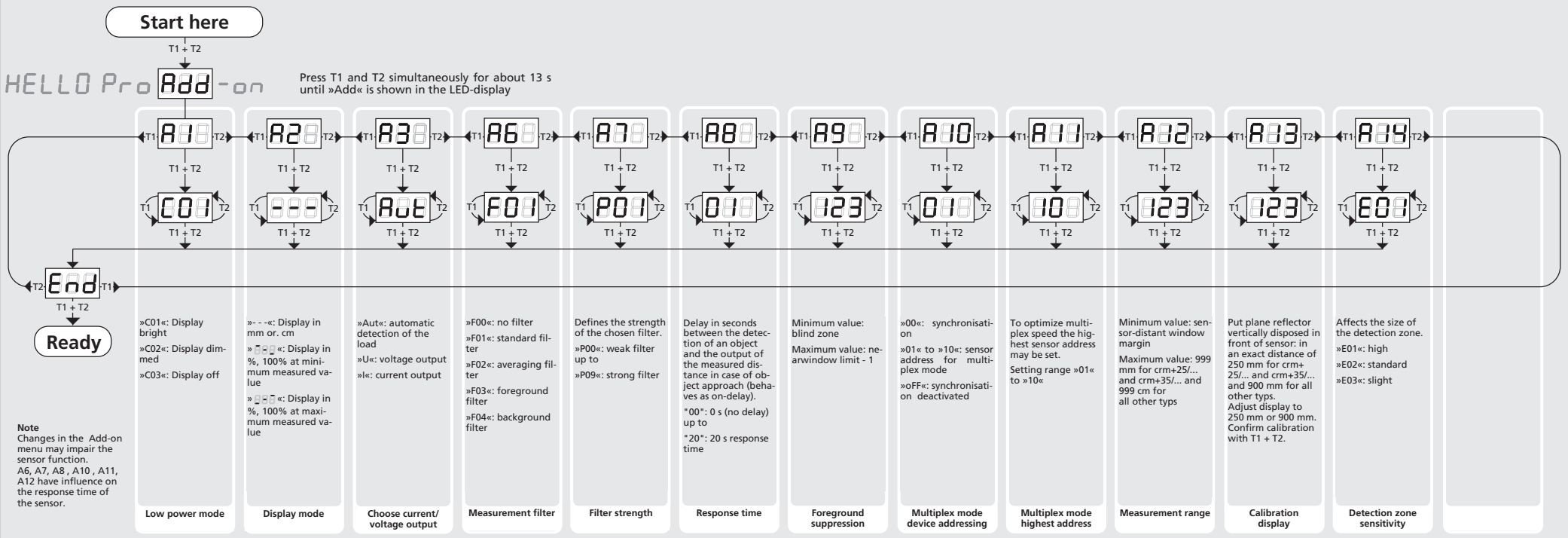

Technical data

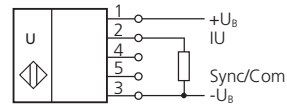

Analogue output

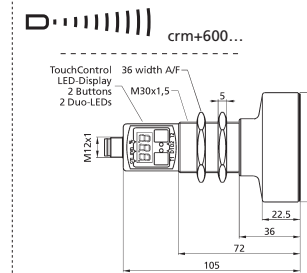
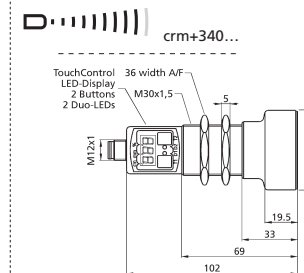
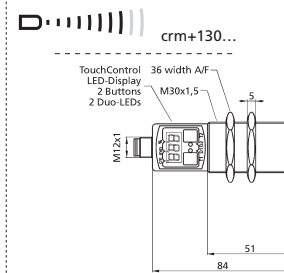
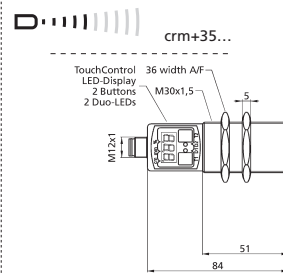
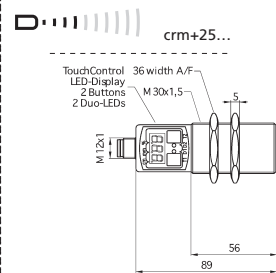

Detection zones for different objects:
The dark grey areas are determined with a thin round bar (10 or 27 mm dia.) and indicate the typical operating range of a sensor. In order to obtain the light grey areas, a plate (500 x 500 mm) is introduced into the beam spread from the side. In doing so, the optimum angle between plate and sensor is always employed. This therefore indicates the maximum detection zone of the sensor. It is not possible to evaluate ultrasonic reflections outside this area.

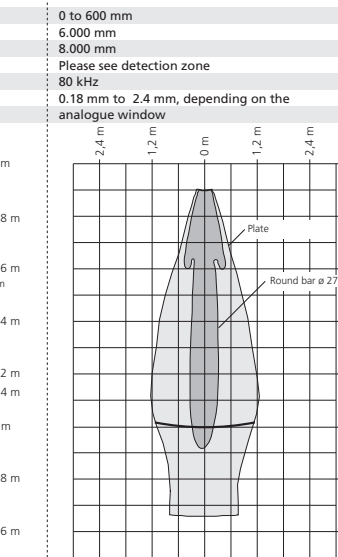
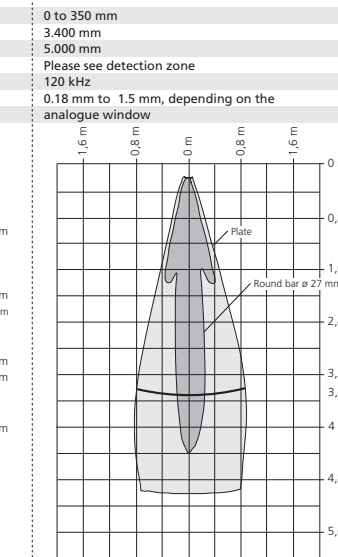
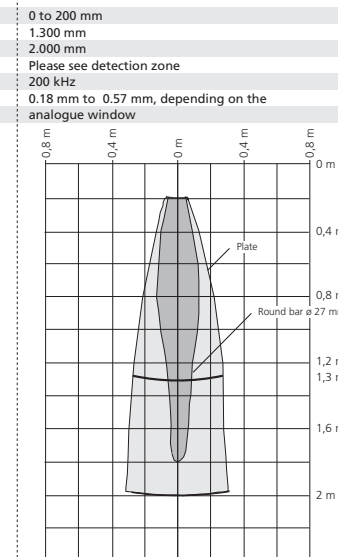
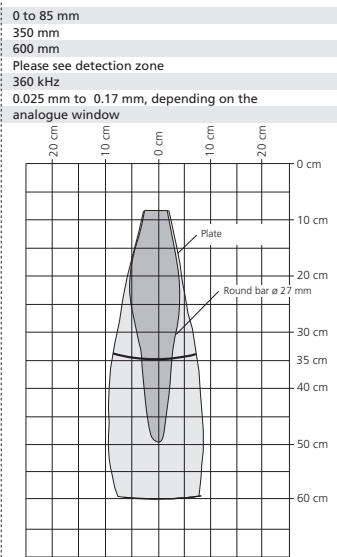
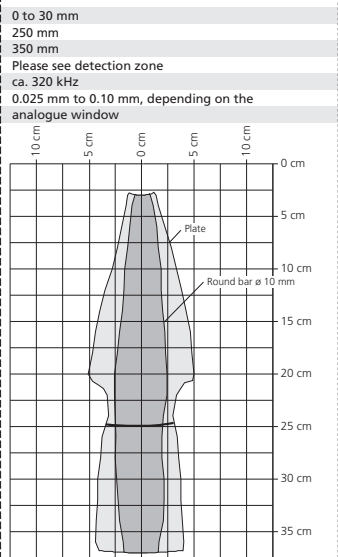

Blind zone	0 to 30 mm	0 to 85 mm	0 to 200 mm	0 to 350 mm	0 to 600 mm
Operating range	250 mm	350 mm	1.300 mm	3.400 mm	6.000 mm
Maximum range	350 mm	600 mm	2.000 mm	5.000 mm	8.000 mm
Angle of beam spread	Please see detection zone				
Transducer frequency	ca. 320 kHz				
Resolution	0.025 mm to 0.10 mm, depending on the analogue window				
Reproducibility	± 0.15 %	± 0.15 %	± 0.15 %	± 0.15 %	± 0.15 %
Accuracy	± 1 % (Temperature drift internal compensated, may be deactivated ¹⁾ , 0.17%/K without compensation)				
Operating voltage U_B	9 V to 30 V DC, reverse polarity protection				
Voltage ripple	±10 %				
No-load supply current	≤ 80 mA				
Housing	Stainless steel 1.4571, plastic parts: PBT, TPU; Ultrasonic transducer: PEEK film, PTFE epoxy resin with glass content				
Class of protection to EN 60529	IP 67				
Norm conformity	EN 60947-5-2				
Type of connection	5-pin initiator plug, PBT				
Controls	2 push-buttons (TouchControl)				
Indicators	3-digit LED-display, 2 three-colour LEDs				
Programmable	Yes, with TouchControl and LinkControl				
Operating temperature	-25°C to +70°C				
Storage temperature	-40°C to +85°C				
Weight	150 g	150 g	150 g	210 g	270 g
Response time¹⁾	32 ms	64 ms	92 ms	172 ms	240 ms
Time delay before availability	< 300 ms				
Order No.	crm+25/IU/TC/E	crm+35/IU/TC/E	crm+130/IU/TC/E	crm+340/IU/TC/E	crm+600/IU/TC/E
Current output 4 – 20 mA	R _i ≤ 100 Ω at 9 V ≤ U _B ≤ 20 V; R _i ≤ 500 Ω at U _B ≥ 20 V				
Voltage output 0 – 10 V	R _i ≥ 100 kΩ at U _B ≥ 15 V, short-circuit-proof				
	Rising/falling output characteristic				

1) Can be programmed with TouchControl and LinkControl