



IO-Link

## Operating Instructions

### Ultrasonic proximity switch with one analogue output, one switched output and IO-Link

- lpc+15/CFU    lpc+15/WK/CFU
- lpc+25/CFU    lpc+25/WK/CFU
- lpc+35/CFU    lpc+35/WK/CFU
- lpc+100/CFU    lpc+100/WK/CFU

### Product description

The lpc+ sensor offers a non-contact measurement of the distance to an object which must be positioned within the sensor's detection zone. The switched output is set conditional upon the adjusted detect distance, as an alternative to the set window margins, a distance proportional analogue signal is output.

Via the Teach-in procedure, the detect distance and operating mode can be adjusted. Two LEDs indicate operation and status of the switching and analogue outputs.

The lpc+ sensors are IO-Link-capable in accordance with IO-Link specification V1.1 and support Smart Sensor Profile like Digital Measuring Sensor.

### Safety instructions

- Read the operating instructions prior to start-up.
- Connection, installation and adjustments may only be carried out by qualified staff.
- No safety component in accordance with the EU Machine Directive.

### Use for intended purpose only

lpc+ ultrasonic sensors are used for non-contact detection of objects.

### Installation

- Mount the sensor at the place of fitting.
- Connect a connection cable to the M12 device plug, see fig. 1.

### Start-up

- Connect the power supply.
  - Carry out sensor adjustment in accordance with the diagram »Sensor adjustment with the Teach-in procedure«.
- Set operation-specific parameters can be locked against changes with the teach-in procedure »Switch on or off Teach-in + Synchronization«.

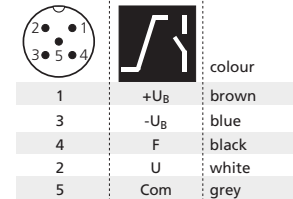

Fig.1: Pin assignment with view onto sensor plug and colour coding of the microsonic connection cables.

### Factory setting

- Detect point operation
- Switched output on NOC
- Detect distance at operating range
- Multifunction input »Com« set to »Teach-in«

- Filter at F01
- Filter strength at P00

### Operating modes

- Three operating modes are available:
- Operation with one detect point  
The switched output is set when the object falls below the set detect point.
  - Window mode  
The switched output is set when the object is within the set window.
  - Two-way reflective barrier  
The switched output is set when the object is between sensor and fixed reflector.

## Contact

### Sensor Partners BV

James Wattlaan 15  
5151 DP Drunen  
The Netherlands  
+31 (0)416 - 37 82 39  
info@sensorpartners.com  
sensorpartners.com

### Sensor Partners BVBA

Z.1 Researchpark 310  
B-1731, Zellik  
Belgium  
+32 (0)2 - 464 96 90  
info@sensorpartners.com  
sensorpartners.com

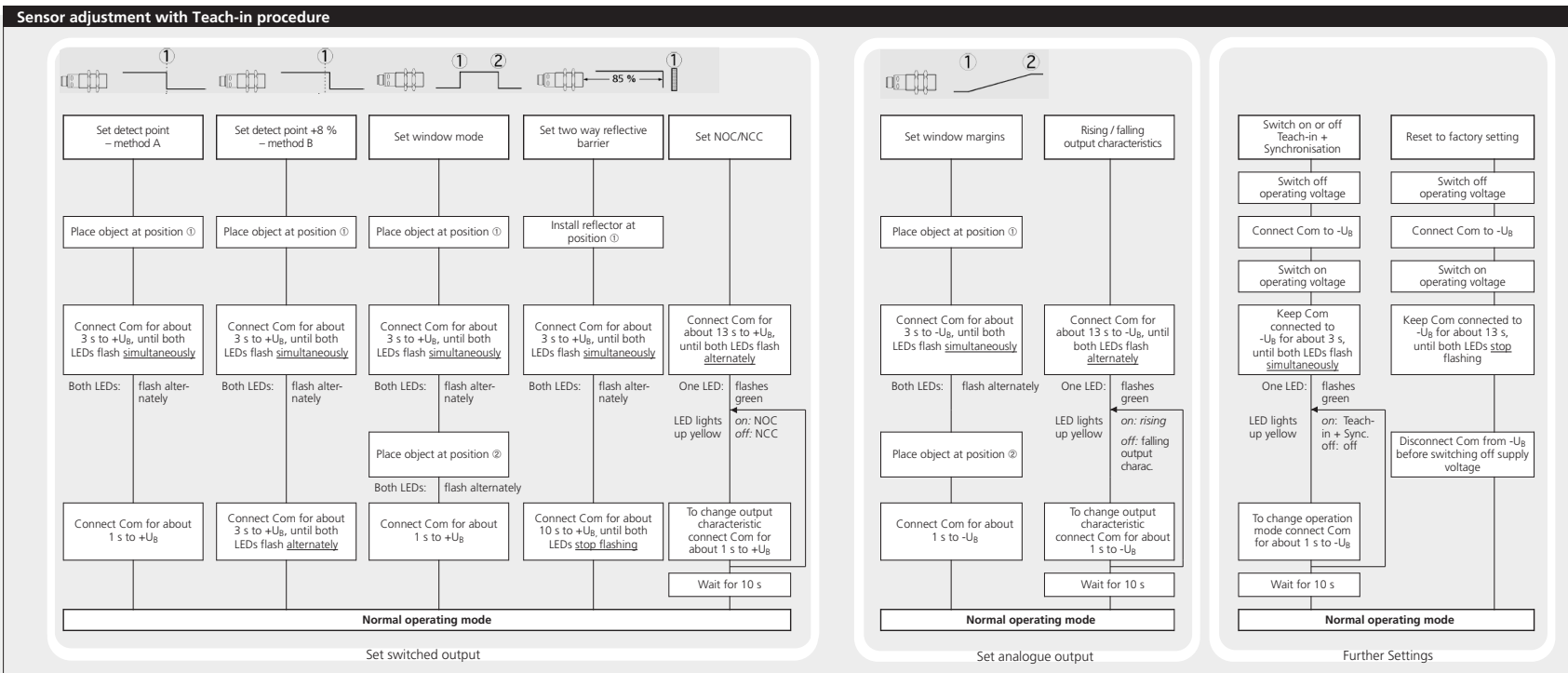

## Synchronisation

If under multiple sensor operation the assembly distance falls below the values shown in fig. 2, the internal synchronisation should be used. For this purpose set the switched outputs of all sensors in accordance with the diagram »Sensor adjustment with the Teach-in procedure«.

Then switch-on the multi-function output »Com« (pin 5) to »Teach-in« and »synchronisation« (see »Further settings«). Finally interconnect each pin 5 of the sensors to be synchronised.





















		
		
		
		
		
		
		

Fig. 2: Assembly distances

## Maintenance

microsonic sensors are maintenance-free. In case of excess caked-on dirt we recommend cleaning the white sensor surface.

## Notes

- The sensors of the lpc+ family have a blind zone, within which a distance measurement is not possible.
- The lpc+ sensors are equipped with an internal temperature compensation. Due to the sensors self heating, the temperature compensation reaches its optimum working-point after approx. 120 seconds of operation.
- In the normal operating mode, an illuminated yellow LED signals that the switched output is switched through.
- The lpc+ sensors have a push-pull switching output.

- In the »Two-way reflective barrier« operating mode, the object has to be within the range of 0-85 % of the set distance.
- In the »Set detect point – method A« Teach-in procedure the actual distance to the object is taught to the sensor as the detect point. If the object moves towards the sensor (e.g. with level control) then the taught distance is the level at which the sensor has to switch the output, see fig. 3.
- If the object to be scanned moves into the detection area from the side, the »Set detect point +8 % – method B« Teach-in procedure should be used. In this way the switching distance is set 8 % further than the actual measured distance to the object. This ensures a reliable switching distance even if the height of the objects varies slightly, see fig. 3.

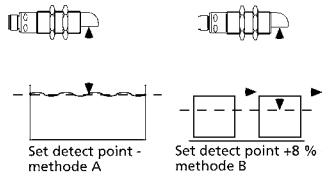
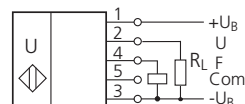

Fig. 3: Setting the detect point for different directions of movement of the object

- The sensor can be reset to its factory setting (see »Further settings«).
- Using the LinkControl adapter LCA-2 (optional accessory) and the LinkControl software for Windows, all Teach-in and additional sensor parameter settings can be optionally undertaken.
- The latest IODD file and information about start-up and configuration of lpc+ sensors with IO-Link, you will find online at: <https://www.microsonic.de/lpc+>



**Technical data**



Push-Pull output in pnp circuit

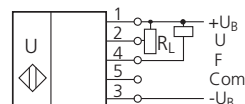

Push-Pull output in npn circuit

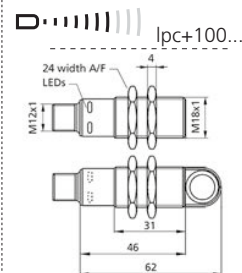
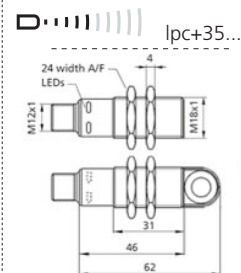
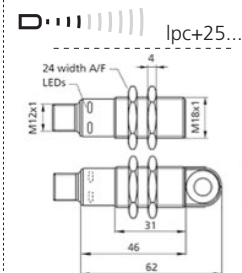
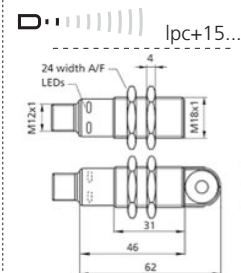

**blind zone** 20 mm  
**operating range** 150 mm  
**maximum range** 250 mm  
**angle of beam spread** see detection zone  
**transducer frequency** 380 kHz  
**resolution** 0,1 mm  
**reproducibility** ± 0.15 %

**detection zones**

for different objects:  
 The dark grey areas represent the zone where it is easy to recognise the normal reflector (round bar). This indicates the typical operating range of the sensors. The light grey areas represent the zone where a very large reflector – for instance a plate – can still be recognized. The requirement here is for an optimum alignment to the sensor. It is not possible to evaluate ultrasonic reflections outside this area.

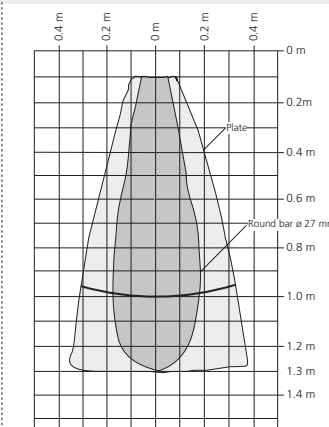
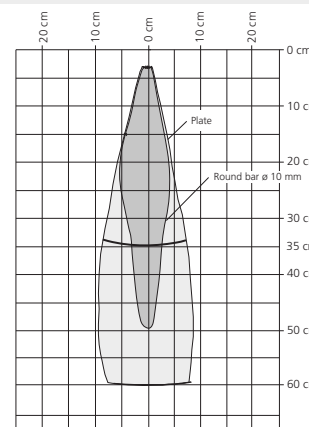
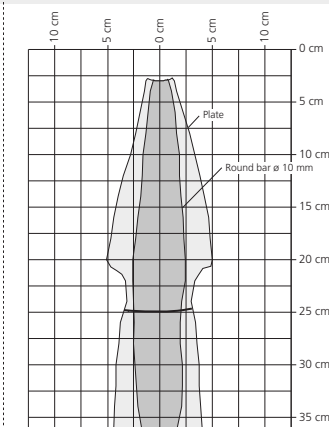
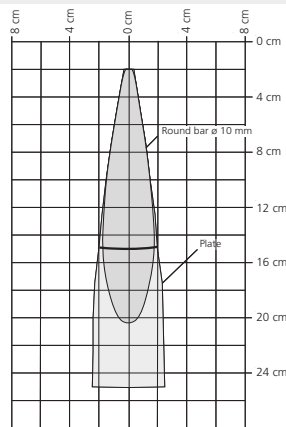

**accuracy** ±1 % (temperature drift internally compensated)  
**operating voltage U<sub>B</sub>** 10 - 30 V DC, reverse polarity protection (Class 2)  
**voltage ripple** ±10 %  
**no-load current consumption** < 60 mA  
**housing** brass sleeve, nickel-plated, plastic parts: PBT; ultrasonic transducer: polyurethane foam, epoxy resin with glass content

**accuracy** ±1 % (temperature drift internally compensated)  
**operating voltage U<sub>B</sub>** 10 - 30 V DC, reverse polarity protection (Class 2)  
**voltage ripple** ±10 %  
**no-load current consumption** < 60 mA  
**housing** brass sleeve, nickel-plated, plastic parts: PBT; ultrasonic transducer: polyurethane foam, epoxy resin with glass content

**accuracy** ±1 % (temperature drift internally compensated)  
**operating voltage U<sub>B</sub>** 10 - 30 V DC, reverse polarity protection (Class 2)  
**voltage ripple** ±10 %  
**no-load current consumption** < 60 mA  
**housing** brass sleeve, nickel-plated, plastic parts: PBT; ultrasonic transducer: polyurethane foam, epoxy resin with glass content

**accuracy** ±1 % (temperature drift internally compensated)  
**operating voltage U<sub>B</sub>** 10 - 30 V DC, reverse polarity protection (Class 2)  
**voltage ripple** ±10 %  
**no-load current consumption** < 60 mA  
**housing** brass sleeve, nickel-plated, plastic parts: PBT; ultrasonic transducer: polyurethane foam, epoxy resin with glass content

**max. tightening torque of nuts** 15 Nm  
**class of protection per EN 60 529** IP 67  
**type of connection** 5-pin M12 circular plug  
**controls** Teach-in via pin 5 (Com)  
**indicators** LED green (operation)  
 LED yellow (state of output)

**max. tightening torque of nuts** 15 Nm  
**class of protection per EN 60 529** IP 67  
**type of connection** 5-pin M12 circular plug  
**controls** Teach-in via pin 5 (Com)  
**indicators** LED green (operation)  
 LED yellow (state of output)

**max. tightening torque of nuts** 15 Nm  
**class of protection per EN 60 529** IP 67  
**type of connection** 5-pin M12 circular plug  
**controls** Teach-in via pin 5 (Com)  
**indicators** LED green (operation)  
 LED yellow (state of output)

**max. tightening torque of nuts** 15 Nm  
**class of protection per EN 60 529** IP 67  
**type of connection** 5-pin M12 circular plug  
**controls** Teach-in via pin 5 (Com)  
**indicators** LED green (operation)  
 LED yellow (state of output)

**programmable synchronisation** Teach-in, LinkControl  
**internal synchronisation** up to 10 sensors  
**operating temperature** -25°C to +70°C  
**storage temperature** -40°C to +85°C  
**switched output** Push-Pull, U<sub>B</sub>-3 V, -U<sub>B</sub>+3 V, I<sub>max</sub> = 100 mA  
 switchable NOC/NCC, short-circuit-proof

**programmable synchronisation** Teach-in, LinkControl  
**internal synchronisation** up to 10 sensors  
**operating temperature** -25°C to +70°C  
**storage temperature** -40°C to +85°C  
**switched output** Push-Pull, U<sub>B</sub>-3 V, -U<sub>B</sub>+3 V, I<sub>max</sub> = 100 mA  
 switchable NOC/NCC, short-circuit-proof

**programmable synchronisation** Teach-in, LinkControl  
**internal synchronisation** up to 10 sensors  
**operating temperature** -25°C to +70°C  
**storage temperature** -40°C to +85°C  
**switched output** Push-Pull, U<sub>B</sub>-3 V, -U<sub>B</sub>+3 V, I<sub>max</sub> = 100 mA  
 switchable NOC/NCC, short-circuit-proof

**programmable synchronisation** Teach-in, LinkControl  
**internal synchronisation** up to 10 sensors  
**operating temperature** -25°C to +70°C  
**storage temperature** -40°C to +85°C  
**switched output** Push-Pull, U<sub>B</sub>-3 V, -U<sub>B</sub>+3 V, I<sub>max</sub> = 100 mA  
 switchable NOC/NCC, short-circuit-proof

**switching hysteresis** 1) 2 mm  
**switching frequency** 1) 25 Hz  
**response time** 1) 32 ms  
**time delay before availability** 1) < 300 ms

**switching hysteresis** 1) 3 mm  
**switching frequency** 1) 25 Hz  
**response time** 1) 32 ms  
**time delay before availability** 1) < 300 ms

**switching hysteresis** 1) 5 mm  
**switching frequency** 1) 12 Hz  
**response time** 1) 64 ms  
**time delay before availability** 1) < 300 ms

**switching hysteresis** 1) 20 mm  
**switching frequency** 1) 10 Hz  
**response time** 1) 80 ms  
**time delay before availability** 1) < 300 ms

**analogue output 0-10 V** R<sub>L</sub> ≥ 100 kΩ, rising/falling characteristic, short-circuit-proof

**analogue output 0-10 V** R<sub>L</sub> ≥ 100 kΩ, short rising/falling characteristic, short-circuit-proof

**analogue output 0-10 V** R<sub>L</sub> ≥ 100 kΩ, rising/falling characteristic, short-circuit-proof

**analogue output 0-10 V** R<sub>L</sub> ≥ 100 kΩ, rising/falling characteristic, short-circuit-proof

**operating voltage U<sub>B</sub>** R<sub>L</sub> ≥ 100 kΩ at U<sub>B</sub> ≥ 15 V, short-circuit-proof  
 terminal reverse polarity protected, Class 2

**operating voltage U<sub>B</sub>** R<sub>L</sub> ≥ 100 kΩ at U<sub>B</sub> ≥ 15 V, short-circuit-proof  
 terminal reverse polarity protected, Class 2

**operating voltage U<sub>B</sub>** R<sub>L</sub> ≥ 100 kΩ at U<sub>B</sub> ≥ 15 V, short-circuit-proof  
 terminal reverse polarity protected, Class 2

**operating voltage U<sub>B</sub>** R<sub>L</sub> ≥ 100 kΩ at U<sub>B</sub> ≥ 15 V, short-circuit-proof  
 terminal reverse polarity protected, Class 2

**norm conformity** EN 60947-5-2  
**order no. directly radiating** lpc+15/CFU  
**weight** 35 g  
**order no. angular head** lpc+15/WK/CFU  
**weight** 40 g

**norm conformity** EN 60947-5-2  
**order no. directly radiating** lpc+25/CFU  
**weight** 35 g  
**order no. angular head** lpc+25/WK/CFU  
**weight** 40 g

**norm conformity** EN 60947-5-2  
**order no. directly radiating** lpc+35/CFU  
**weight** 35 g  
**order no. angular head** lpc+35/WK/CFU  
**weight** 40 g

**norm conformity** EN 60947-5-2  
**order no. directly radiating** lpc+100/CFU  
**weight** 35 g  
**order no. angular head** lpc+100/WK/CFU  
**weight** 40 g

1) Can be programmed with LinkControl