

XS930S1PAM12

DATASHEET

Sensor Partners BV

 James Wattlaan 15
5151 DP Drunen
The Netherlands

 +31 (0)416 - 37 82 39

 info@sensorpartners.com

 sensorpartners.com

Sensor Partners BVBA

 Z.1 Researchpark 310
B-1731, Zellik
Belgium

 +32 (0)2 - 464 96 90

 info@sensorpartners.com

 sensorpartners.com

Product datasheet

Characteristics

XS930S1PAM12

inductive sensor XS9 M30 - L64mm - full SS 316L - Sn20 mm - 12..24VDC - M12



Main

Range of product	OsiSense XS
Series name	Application
Sensor type	Inductive proximity sensor
Device application	Food and beverage
Sensor name	XS9
Sensor design	Cylindrical M30
Size	64 mm
Body type	Single piece body
Enclosure material	Stainless steel 316L
Type of output signal	Discrete
Wiring technique	3-wire
[Sn] nominal sensing distance	20 mm
Discrete output function	1 NO
Discrete output type	PNP
Electrical connection	Male connector M12, 4 pins
[Us] rated supply voltage	12...24 V DC with reverse polarity protection
Switching capacity in mA	<= 200 mA with overload and short-circuit protection
IP degree of protection	IP69K conforming to DIN 40050 IP68 conforming to IEC 60529

Complementary

Thread type	M30 x 1.5
Detection face	Frontal
Detector flush mounting acceptance	Flush mountable
Material	Stainless steel 316L
Front material	Stainless steel 316L
Operating zone	0...16 mm
Differential travel	1...15 % of Sr
Repeat accuracy	<= 5 % of Sr
Output circuit type	DC
Status LED	Output state: 1 LED (yellow)

Supply voltage limits	10...30 V DC
Maximum residual current	0.1 mA open state
Switching frequency	<= 100 Hz
Maximum voltage drop	<2 V (closed)
Current consumption	<= 10 mA no-load
Maximum delay first up	40 ms
Maximum delay response	0.00006 ms
Maximum delay recovery	0.015 ms
Marking	CE
Threaded length	42 mm
Height	30 mm
Length	64 mm

Environment

Product certifications	CULus Ecolab
Ambient air temperature for operation	-25...85 °C
Ambient air temperature for storage	-25...85 °C
Vibration resistance	25 gn amplitude = +/- 1 mm (f = 10...55 Hz) conforming to IEC 60068-2-6
Shock resistance	30 gn for 11 ms conforming to IEC 60068-2-27

Offer Sustainability

REACH Regulation	REACH Declaration
EU RoHS Directive	Pro-active compliance (Product out of EU RoHS legal scope) EU RoHS Declaration
Mercury free	Yes
RoHS exemption information	Yes

Contractual warranty

Warranty	18 months
----------	-----------

Dimensions

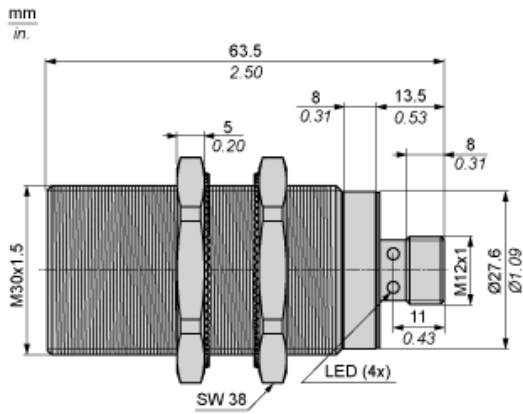

Minimum Mounting Distances in mm

Side by side

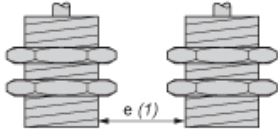

$e (1) \geq 80 \text{ mm}/3.15 \text{ in.}$

Face to face

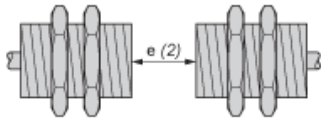

$e (2) \geq 70 \text{ mm}/2.76 \text{ in.}$

Facing a metal object

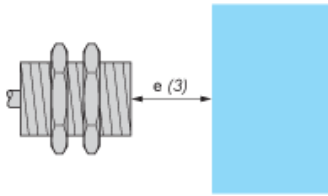

$e (3) \geq 60 \text{ mm}/2.36 \text{ in.}$

Mounted in a metal support

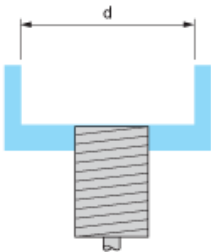

$d \geq 90 \text{ mm}/3.54 \text{ in.}$

Wiring Schemes

M12 connector

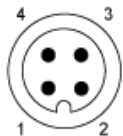

PNP

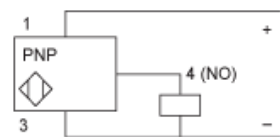

- 1 : (+)
- 2 : Not connected
- 3 : (-)
- 4 : NO Output