



AB series

M4 cylindrical miniaturized inductive sensors



M4 cylindrical miniaturized

features

- Complete range of cylindrical ultraminiaturized inductive sensors M4
- IP67 protection degree



web contents



- Application notes
- Photos
- Catalogue / Manuals



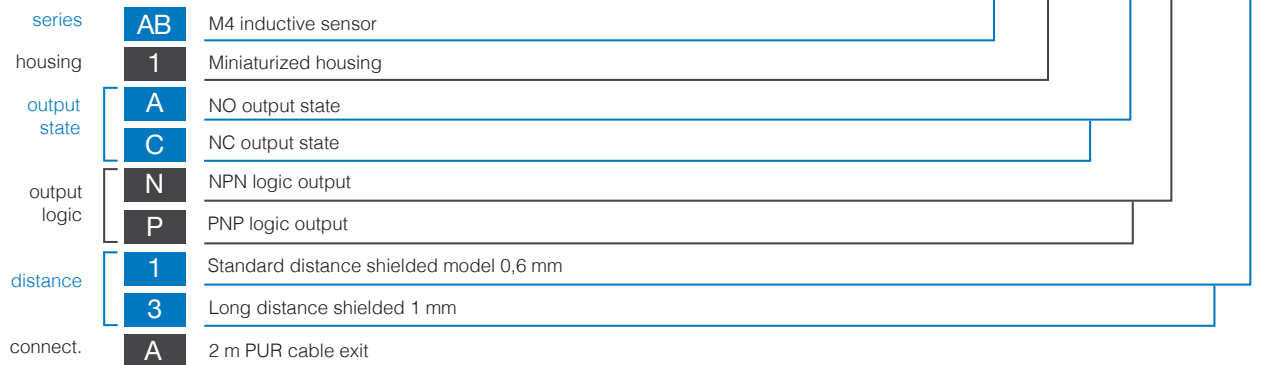

code description

AB 1 / A P - 1 A



available models

model	installation	sensing	plug	distance (mm)	PNP/NO	NPN/NO	PNP/NC	NPN/NC
M4	shielded	standard	cable	0.6 mm	AB1/AP-1A	AB1/AN-1A	AB1/CP-1A	AB1/CN-1A
		long distance		1 mm	AB1/AP-3A	AB1/AN-3A	AB1/CP-3A	AB1/CN-3A

	AB ^{*/**} -1*	AB ^{*/**} -3*
		
nominal sensing distance S _n	0,6 mm	1 mm
operating distance	0...0,48 mm	0...0,81 mm
hysteresis	1...20%	
standard target	4x4 mm FE360	
repeatability	5% @UB=20...30 V; T _a = 23°C ±5°C	
operating voltage	10...30 Vdc	
ripple	≤ 10%	
output type	NPN or PNP - NO or NC	
output current	≤ 100 mA	
output voltage drop	≤ 1.5 V @ 100mA	
no-load supply current	≤ 10 mA	
leakage current	≤ 10 µA	
switching frequency	3 kHz	3.5 kHz
power on delay	≤ 50 ms	
temperature range	-25°C...+70°C	
temperature drift	10%	
power supply protections	polarity reversal	
output protection	short circuit (auto reset), overvoltage pulses	
EMC	in conformity with the EMC Directive according to IEC 60947-5-2	
shock and vibration	IEC 60947-5-2	
protection degree	IP67	
housing material	stainless steel AISI 303	
active head material	PBT	
reduction factor	see table	
LEDs	on (yellow LED)	
connection	2m PUR cable	

correction factors

model	FE 360	copper	aluminium	brass	stainless steel
AB1 ^{*/**} -1*	1	0.23 ± 10%	0.26 ± 10%	0.31 ± 10%	0.52 ± 10%
AB1 ^{*/**} -3*	1	0.30 ± 10%	0.22 ± 10%	0.32 ± 10%	0.57 ± 10%

installation

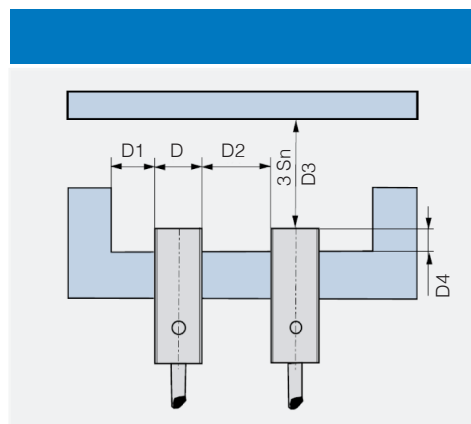

model	D4	D1	D2	D3
AC1 ^{*/**} -1*	≥ 0 mm ⁽¹⁾	≥ 2 mm	≥ 4 mm	≥ 1.8 mm
AC1 ^{*/**} -3*	≥ 0mm ⁽²⁾	≥ 2 mm	≥ 4 mm	≥ 3 mm

⁽¹⁾ ≥ 2.5 mm without ferro-magnetic material
⁽²⁾ ≥ 2.5 mm without ferro-magnetic material

electrical diagrams of connections



M4 cylindrical
miniaturized

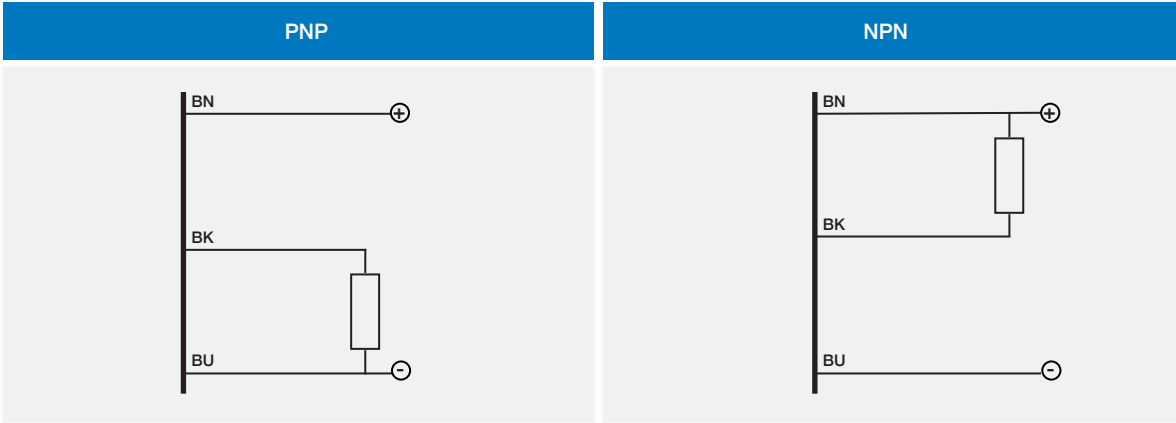

- BN brown
- BU blue
- BK black
- WH white

response diagram

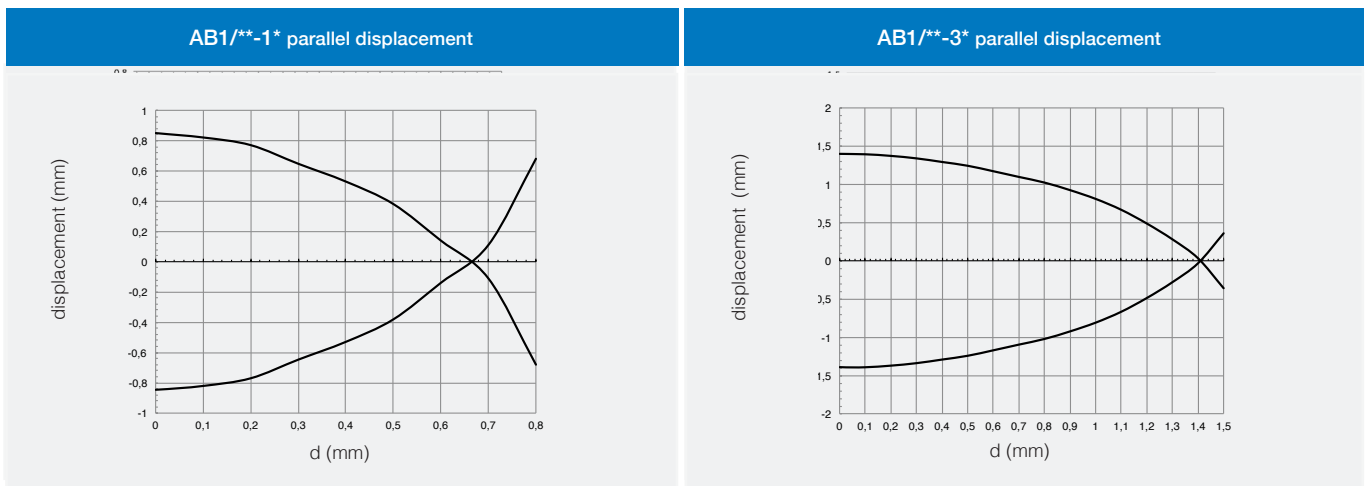



dimensions (mm)

M4 cylindrical
miniaturized

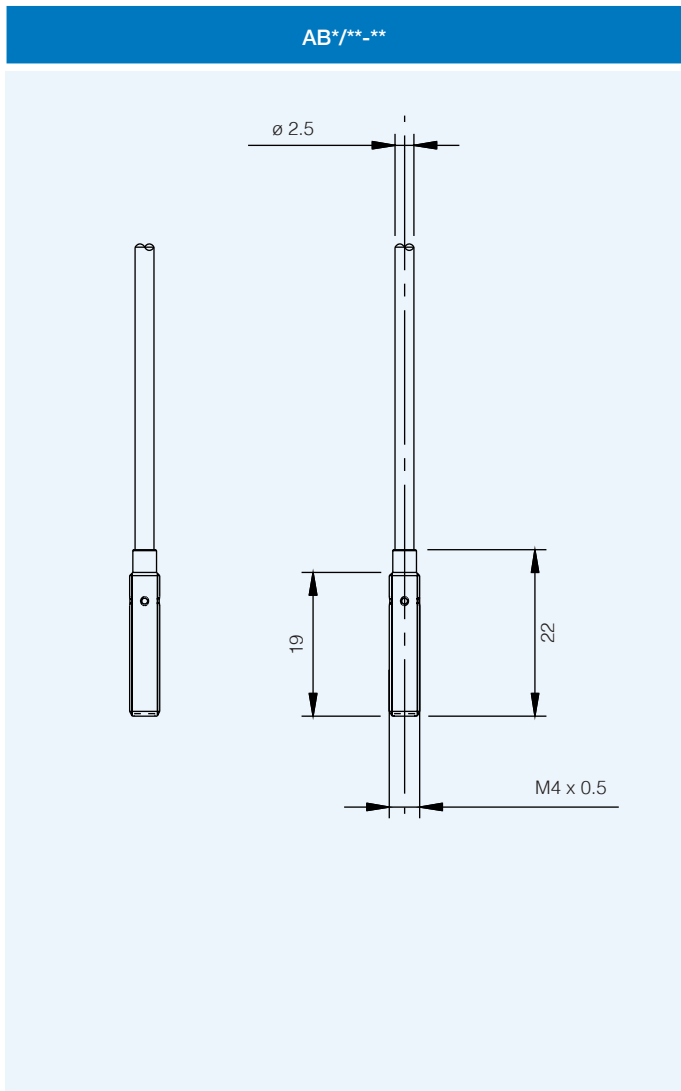

dimensions (mm)

accessories included in all models

